

New Rev



SPECIFICATIONS

CUSTOMER : _____
DESCRIPTION : IR RECEIVER MODULE
MODEL NO. : DS-T1B38DSC-MVI1
ISSUED DATE : _____

	ISSUE	REVIEW	REVIEW	APPR'D
ISSUED DEPT.				



Company Name: DKC CORPORATION CO.,LTD

ADDRESS : (Sigma2) C-223Ho, Tancheonsang-Ro 164, Bundanggu, Seongnam-si, Gyeonggi-do, Republic of Korea





TEL :+82-31-603-6646

Fax :+82-31-718-6646

◆ Revision History

Revision	Issue	Modification notice	Customer approval
A	21. Mar. 16	Initial Status Report	

◆ Drawing View

Right	Front	Left	Top	Bottom
				

◆ **Description**

The DS-T1B..., DS-T1C Series are miniaturized receiver for infrared remote control system.

A PIN Photodiode and preamplifier are assembled on lead frame, the epoxy package is designed as IR filter. The module has excellent performance even in disturbed ambient light application and provides protection against uncontrolled output pulses.

This component has not been qualified according to automotive specifications.

◆ **Features**

- Photo detector and preamplifier in one package
- Low supply current
- Wide operating voltage : 2.7V ~ 5.5 V
- Available for Carrier Frequencies between 32.7kHz to 56kHz,
- Internal filter for PCM frequency
- Insensitive to supply voltage ripple and noise
- Improved shielding against EMI (Built-in Shield Case)
- Improved immunity against ambient light (Built-in Filter & AGC Circuit)
- Open collector output (Built-in inter pull-up resistor – typ. 50kΩ)
- Compliant to RoHS Directive 2002/95/EC and in accordance to WEEE 2002/96/EC

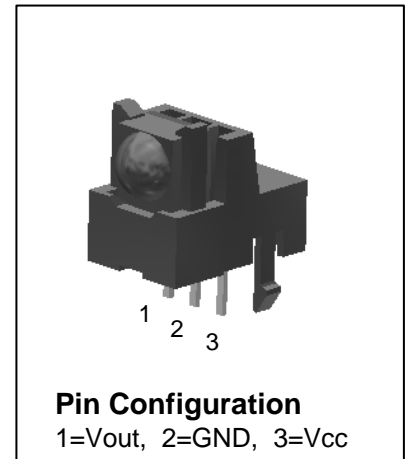

◆ **Applications**

- TV, VCR, AUDIO, SET TOP BOX
- Home Appliances
- Remote Control Equipment

◆ **Ordering Info.(Carrier frequencies)**

Type	Carrier Frequency
DS-□□□32DSC	32.7 kHz
DS-□□□37DSC	36kHz & 36.7 kHz
DS-□□□38DSC	37.9 kHz
DS-□□□40DSC	40.0 kHz
DS-□□□56DSC	56.7 kHz

◆ **Block Diagram**

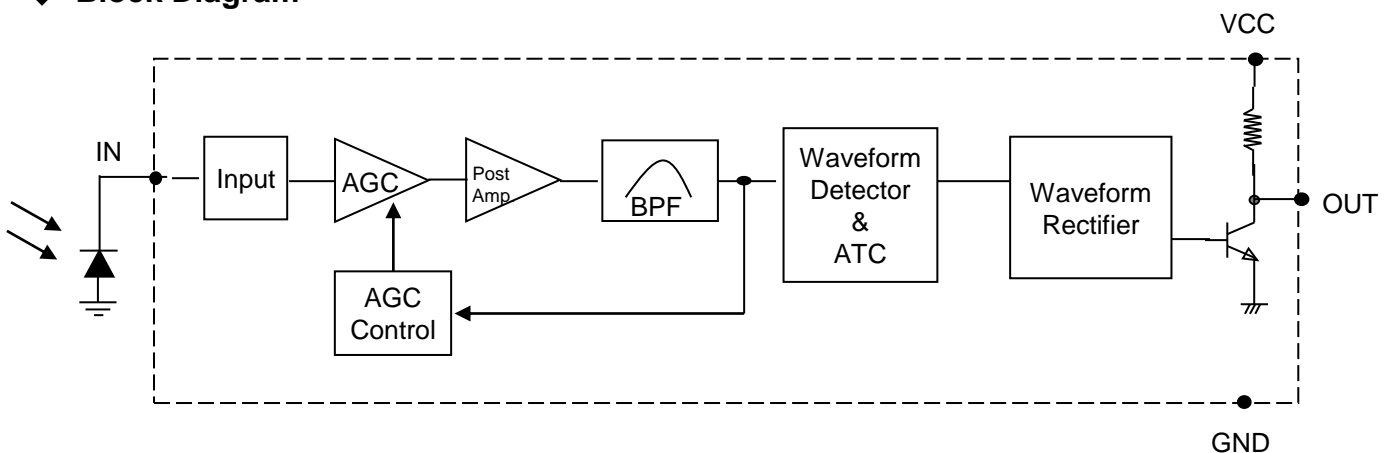



◆ Absolute Maximum Ratings

(Ta = 25 °C)

Parameter	Symbol	Min.	Max.	Unit
Supply Voltage	VCC	0	6.0	V
Supply Current	ICC	0	3.0	mA
Output Voltage	Vout	0	6.0	V
Output Current	Iout	0	2.5	mA
Storage Temperature	Tstg	-30	85	°C
Soldering Temperature	Tsd	260 °C ±5 °C, Max 10 sec		°C

* Stress above those listed under “Absolute Maximum Ratings” may cause permanent damage of device. This is stress rating only and functional operation of the device at these or any other conditions above those indicated in the operational sections of this specification is not implied. Exposure to absolute maximum rating conditions for longer periods may affect device reliability.

◆ Recommended operating Conditions

Parameter	Symbol	Min.	Max.	Unit
Operating Voltage	VCC	2.7	5.5	V
Input Frequency	fin	32	57	kHz
Operating temperature	Tamb	-20	80	°C

◆ Electro-optical Characteristics

(Ta = 25 °C)

Parameter	Symbol	Conditions	Min	Typ	Max	Unit	
Operating Voltage	Vcc	-	2.7	-	5.5	V	
Supply Current	Icc	No input signal	Vcc=5V	0.2	0.53	0.7	mA
			Vcc=3V		0.4		
Peak Wave Length (*1)	λ_P		-	940	-	nm	
B.P.F Center Frequency (*2)	fo		-	37.9	-	KHz	
High Level Output Voltage (*1)	VOH	30cm over the ray axis	Vcc-0.5	-	-	V	
Low Level Output Voltage (*1)	VOL		-	0.2	0.4	V	
High Level Output Pulse Width (*1)	TWH	Burst Wave = 600 μ s Period = 1.2ms	400	-	800	μ s	
Low Level Output Pulse Width (*1)	TWL		400	-	800	μ s	
Arrival Distance (*1)	L	Fig. 1,2,3	±0°	25	-	-	m
			±30°	15	-	-	
Output Form	Active Low						

※ 1. 600/600 μ s burst wave is transmitted by standard(Fig.2, Fig.3) transmitter. However, it measured after the initial transmission pulse is 10(60ms) pulse.

Arrival Distance Effected by Environment

※ 2. The following band pass frequencies are available.(32.7kHz/36.7kHz/37.9kHz/40kHz/56.7kHz)
Carrier frequencies adjusted by zener-diode fusing method.

◆ **Measurement Conditions (Ta=25°)**

[Fig.1] **Output Waveform (at freq.=37.9KHz)**

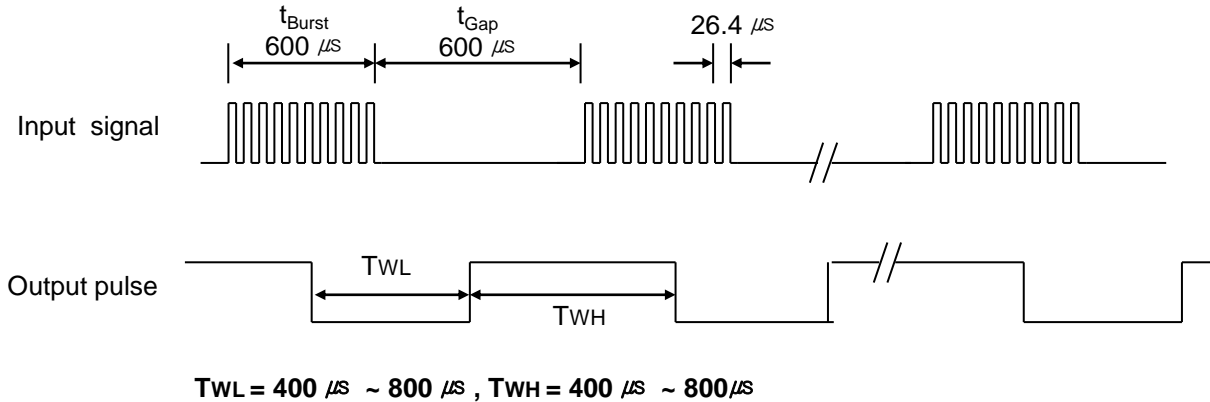

[Fig.2] **Transmitter**

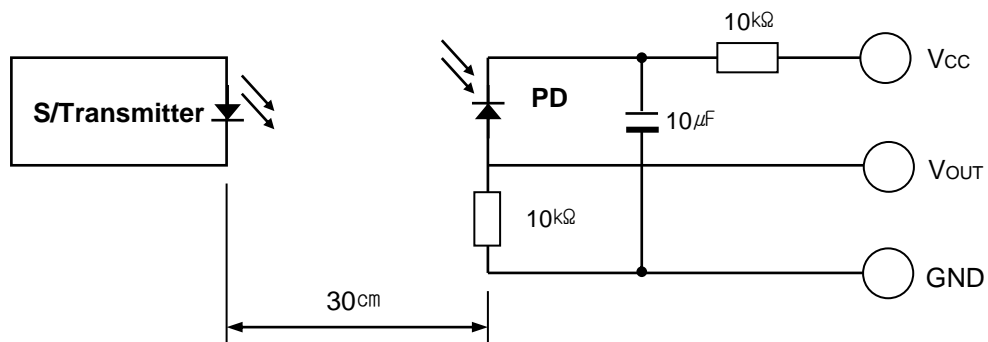

※ The specifications shall be satisfied under the following conditions. The standard transmitter shall be specified of the burst wave form adjusted to V_{OUT} 200mVp-p upon P_o measuring circuit Standard Transmitter

[Fig.3] **Test condition of arrival distance**

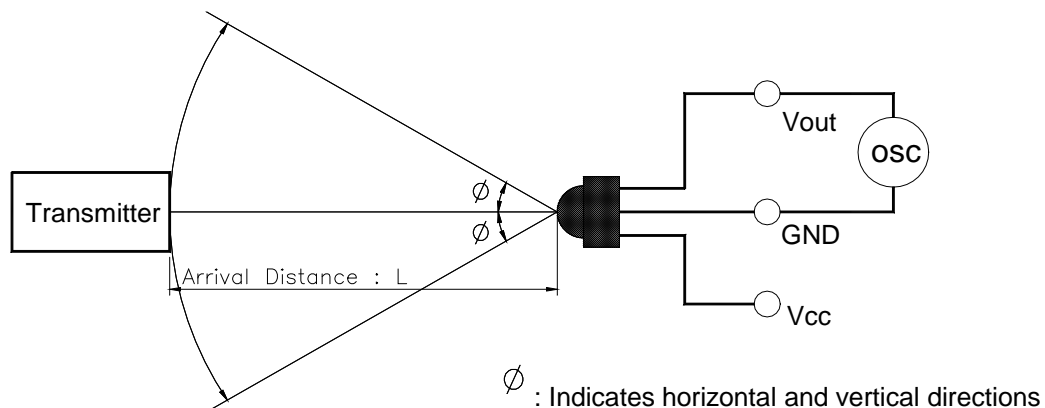

[Measurement condition for arrival distance]

☞ Ambient light source : Detecting surface illumination shall be irradiate 200 ± 50 Lux under ordinary white fluorescence lamp without high frequency lighting

◆ Electrical / Optical Characteristics (Ta=25°)

[Fig.4] Supply Current vs. Voltage

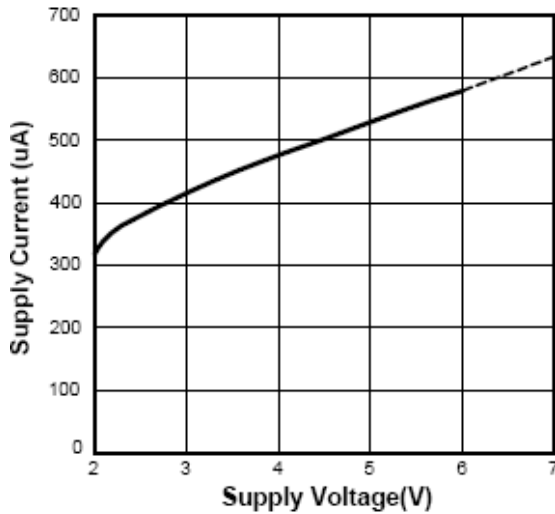

[Fig.5] Sensitivity vs. Supply Voltage

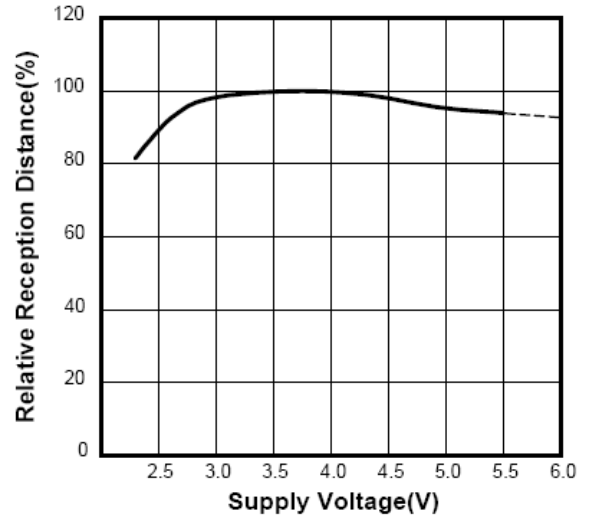

[Fig.6] Output Pulse Width vs. Distance

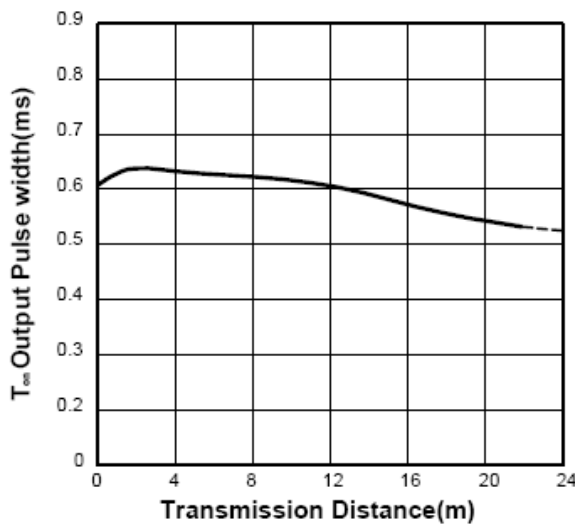

[Fig.7] Directivity

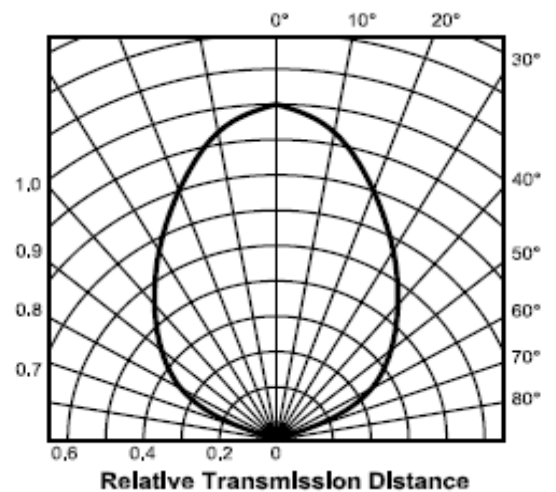

[Fig.8] B.P.F Fc Curve

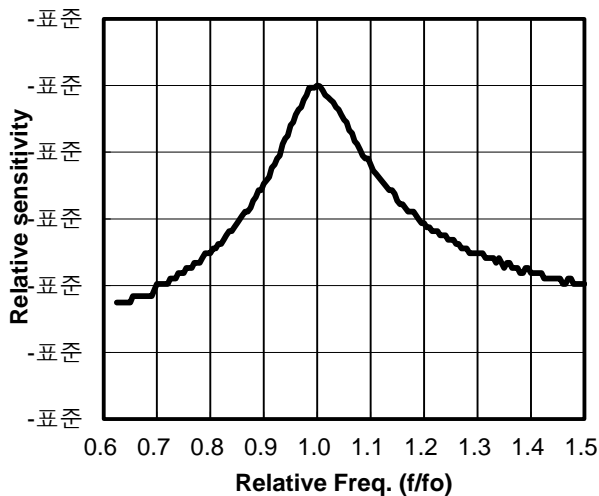

[Fig.9] Relative Spectral Sensitivity

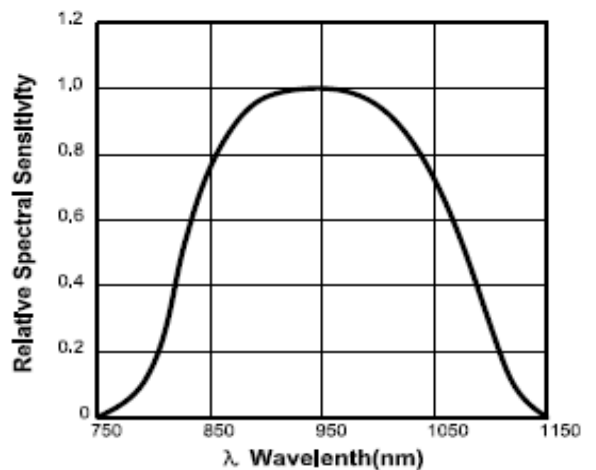

◆ Data Signal Limitation for DS-T1XXXDSC Series ;

Item	Symbol	Time
Minimum Data word length	-	Max. 100ms
Minimum Burst length	t_{Burst}	Min. 450us
Minimum Gap Time	t_{Gap}	Min. 450us
Minimum data pause time	t_{Pause}	Min. 59ms
Required data pause time	$t_{Pause} > \{ (\sum t_{Burst} * 2) / 2.5 \} + 30$	

* note 1)

: t_{Pause_min} Could be changed by different data word format. Therefore, for new application on sets please refer to "Required data pause time(t_{Pause})" on above.

[Fig. 10] Data Signal diagram

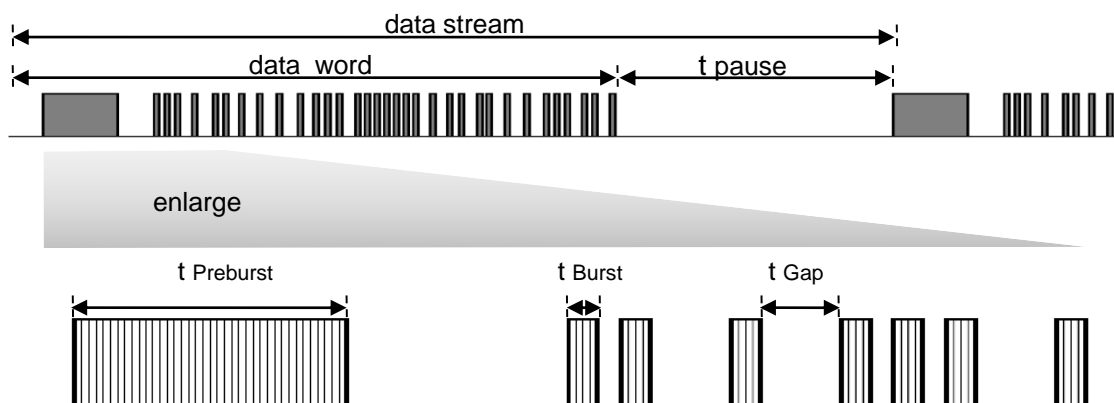

- t_{Burst} ; length of a burst in pulses of the carrier frequency.
- t_{Gap} ; length of the gap between two burst in pulses of carrier.
- t_{pause} ; length of the pause between two data words.
- $t_{Preburst}$; lead code of data word

◆ Suitable Data format for DS-T1XXXDSC Series ;

Item		Note
Suitable Data Format	NEC Simple code Format	Single : Enable Repeat : Enable
Not Recommend Data Format	Toshiba Full Repeat Code ,Philips RC5, RC6	Single : Enable Repeat : Disable
	Sony 12bit ,Sharp, Zenith Code Format	
	Matsushita, JVC, RCA Code Format	
	Sony 15/20 bit , RCA Code Format	
	Philips RCMM, RECS-80, XMP Code Format	Single : Disable Repeat : Disable

◆ External Application Circuit - Power Noise reduction & ESD Protection

A further influence to the IR receiver modules may come from a supply voltage which is not stable. Such a disturbed supply voltage can be caused by switching power supply, which is not filtered well or by other components in the circuit which produced spikes on the supply line. This disturbed supply will reduce the sensitivity of receiver modules. This application circuit will filter the disturbed supply voltage.

[Fig 11] Application for power supply ripple suppression

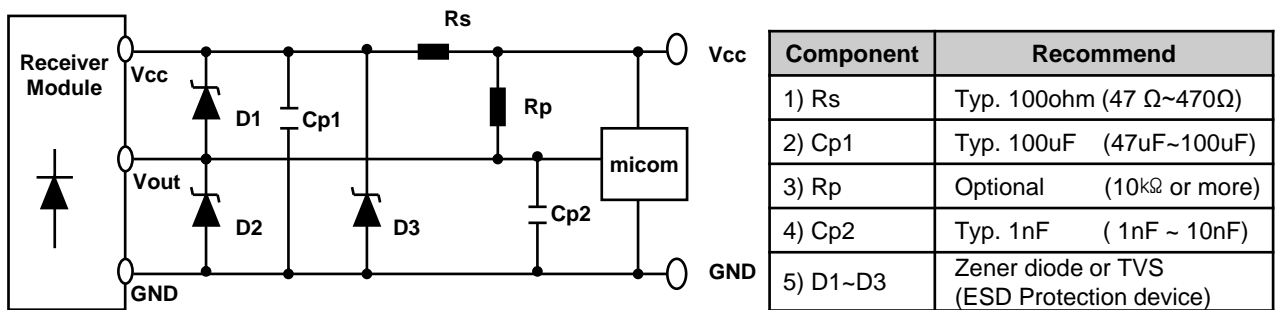

◆ Reliability Test Items

Parameter	Test conditions	Remark
High Temperature	Ta=+85, Vcc=5.0V t=240h	※1, ※2
Low Temperature	Ta=-30, Vcc=5.0V t=240h	※1, ※2
High Temp./ High Humidity	Ta=+85℃ 85%RH, Vcc=5.0V t=240h	※1, ※2
Heat Cycle	Ta=-25℃ (0.5h) to +85℃ (0.5h) 20 cycle	※2, ※3
Fall Test	Height=75cm, 3 times	※4

- ※ 1. Supply voltage of load test is 5V.
- ※ 2. Electro-optical characteristics shall be satisfied after leaving 2 hours in the normal condition.
- ※ 3. Heat cycle test shall repeat above condition 20 times under no load.
- ※ 4. The test devices shall be dropped three time on the hard wooden board from a height of 75cm.

◆ Material Configuration

Parameter	Materials	Configuration	Remark
IC	NEO Device(ND5303X)	Silicon(99%)	
Photo diode	ODTech (OSD2130)	Silicon(99%)	
Lead frame	ICHEN (LF2011DSA)	Iron(99.5%), Silver(0.5%)	
Epoxy resin	Nepes (CMC220G)	Resin(55.5%), Hardener(45.5%)	
Silver epoxy	Feedpool (FP5100)	Silver(80%), Resin(10%), Hardener(10%)	
Bond wire	HeeSung (1.2Mil HP)	Gold(99.99%)	
Injection mold	TAEWOO (VI1)	Polycarbonate(82%), Glass fiber(18%) Vicat Temp (220~230℃)	Outside

◆ Appearance & Dimensions

1) Package Dimension(Unit: mm)

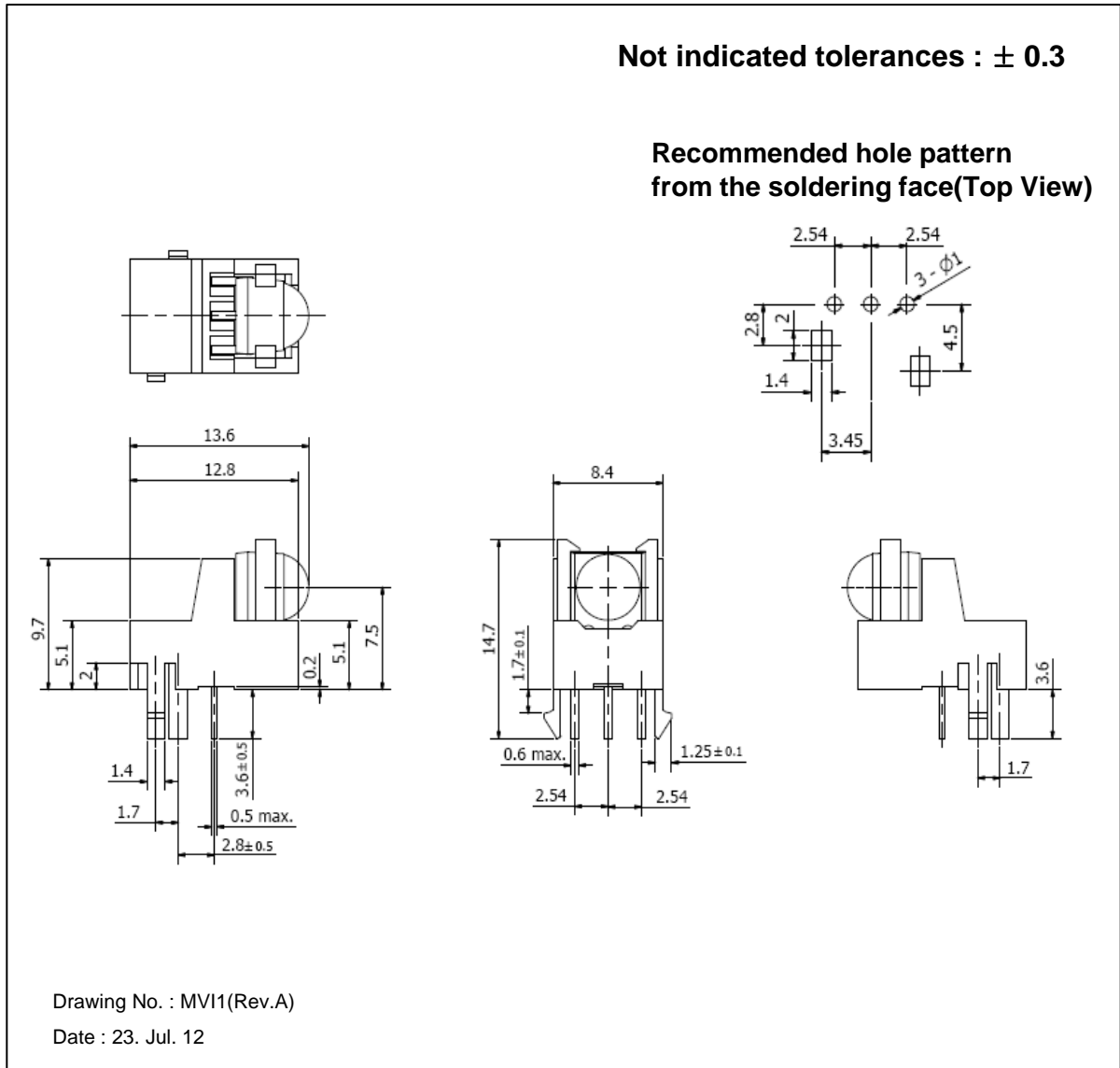

2) Laser-Marking on IR receiver module

Outline(Bottom)	Lot tracking	Specification	Remark
	3(1 digit)	Year	0~9
	08(2 digit)	Week	01~99
	S(1 digit)	Lot Code	A~Z
	03(2 digit)		01~99